

PLANOS DE CALEFACCIÓN



¿QUÉ HACE FALTA?



REPARTO EN VIVIENDAS

Monotubular

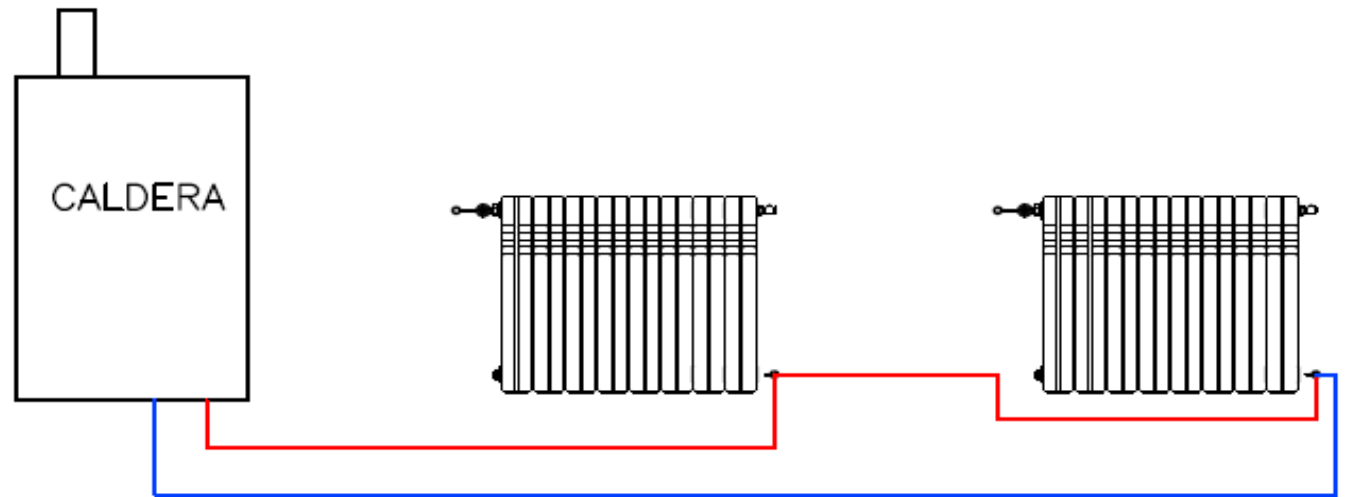

Bitubular

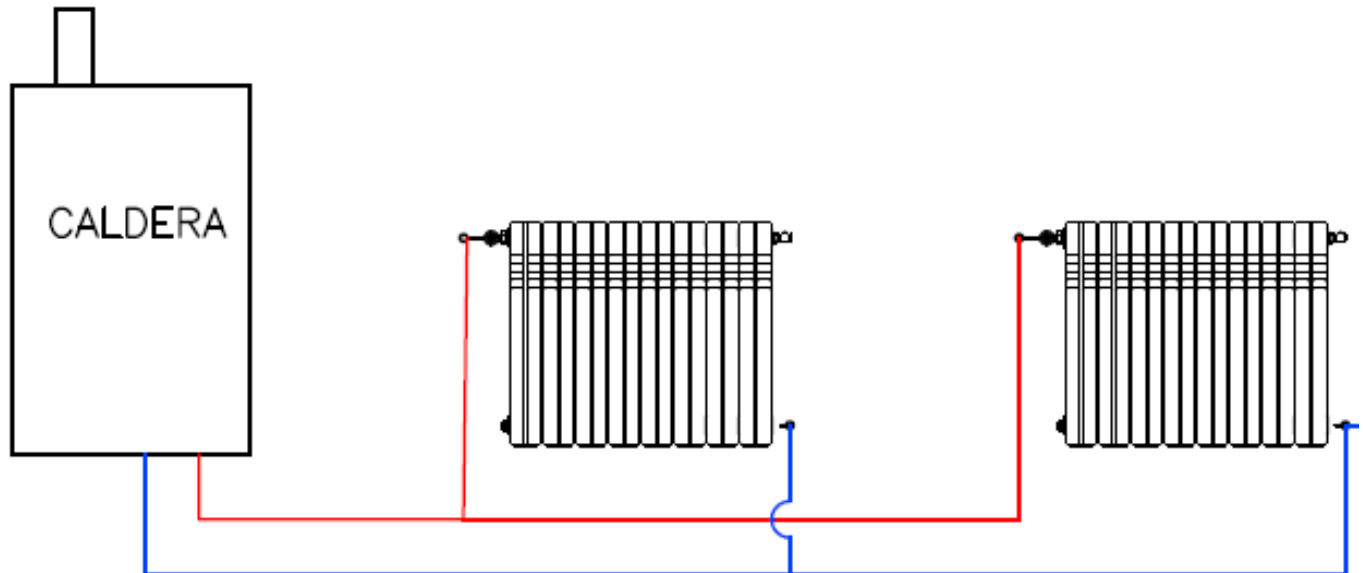

INSTALACIÓN MONOTUBULAR

- Caldera
- Radiadores
 - Elementos
- Tubería
 - NO diámetro







INSTALACIÓN BITUBULAR

- Caldera
- Radiadores
 - Elementos
- Tubería
 - Diámetros









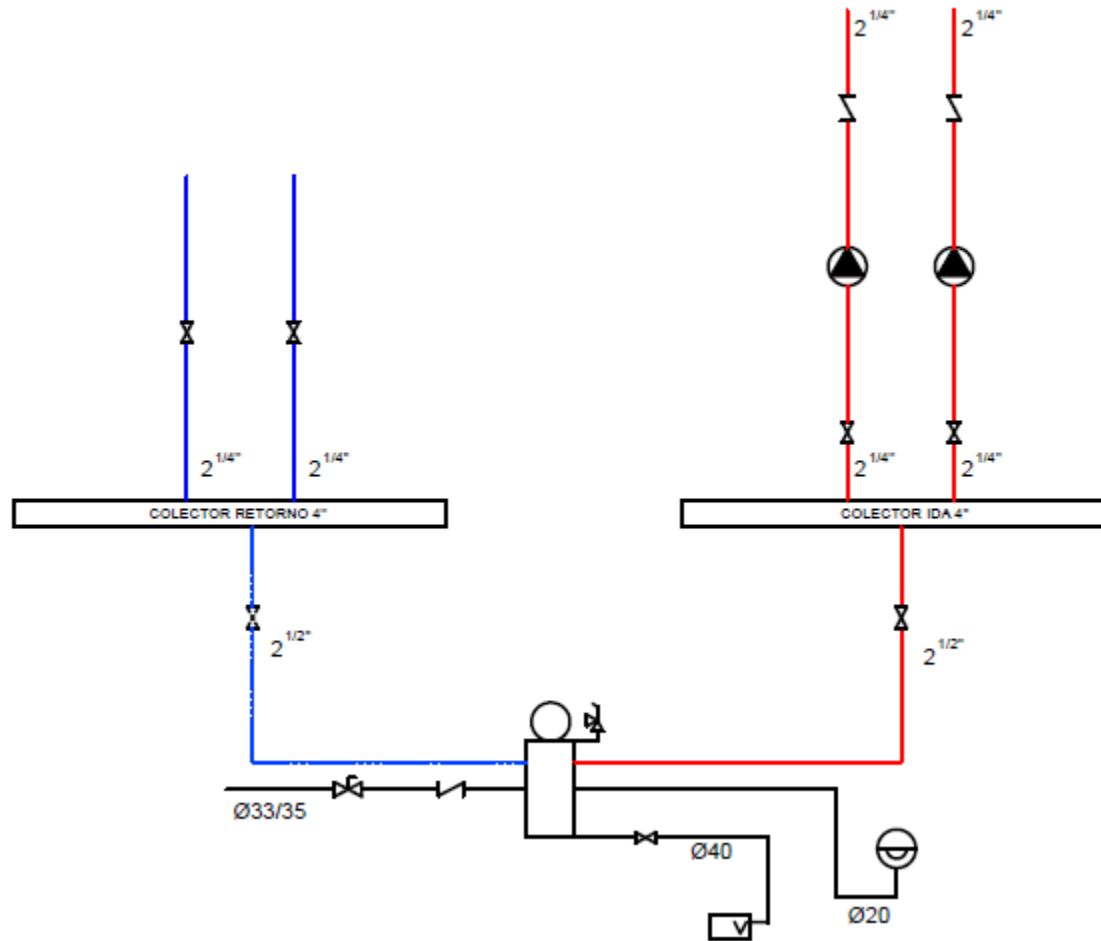

LEYENDA

INSTALACIÓN DE CALEFACCIÓN	
	Radiador CALIDOR
	Caldera NEODENS PLUS 24/24 F GAS NATURAL
	Termostato ambiente
	Tubería de ida
	Tubería de retorno

SALA DE CALDERAS



LEYENDA SALA DE CALDERAS

	VÁLVULA SEGURIDAD
	VÁLVULA ANTIRETORNO
	VÁLVULA CORTE
	VÁLVULA BOLA
	MANÓMETRO
	VASO EXPANSIÓN 40L
	SUMIDERO
	BOMBA IMPULSIÓN
	CALDERA NEODENS PLUS 24/24 F



ADISA
CALEFACCION

CE



SISTEMA DE COLUMNAS

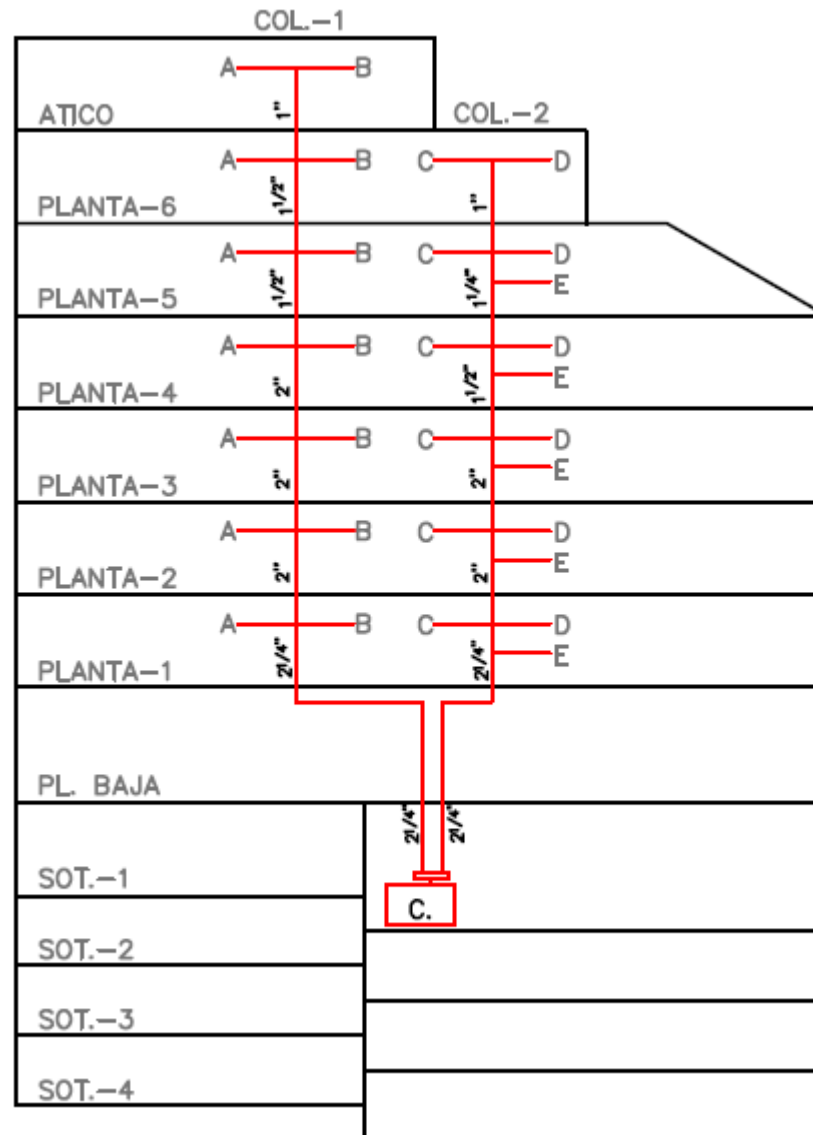

EJEMPLO PLANO SALA DE CALDERAS

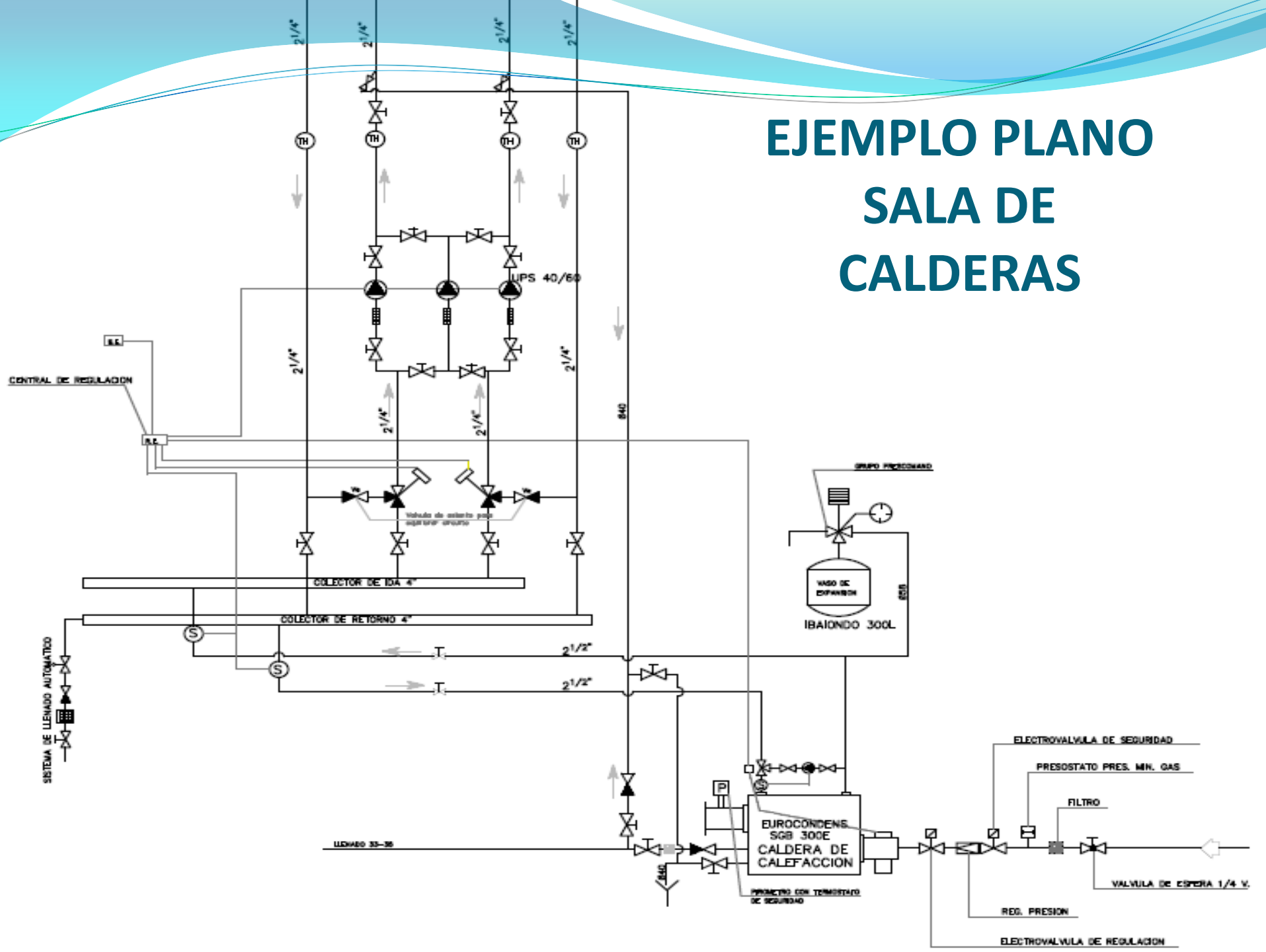



Gracias por su
atención